

5A ULTRA FAST RECOVERY RECTIFIER

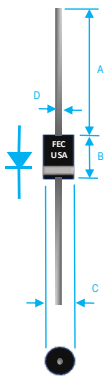

Dim.	Value in [mm]	
	Min.	Max.
A	1.000[25.40]	—
B	0.335[8.51]	0.375[9.52]
C	0.297[7.50]	0.220[5.59]
D	0.048[1.22]	0.052[1.32]

PRODUCT FEATURES

1. FLAMMABILITY CLASSIFICATION: 94V-0
2. LOW LEAKAGE
3. HIGH SURGE CURRENT CAPABILITY
4. ULTRA FAST SWITCHING
5. CASE: MOLDED PLASTIC, DO15
6. POLARITY: INDICATED BY CATHODE BAND
7. WEIGHT : 1.2 GRAMS
8. TERMINALS : PER MIL-STD-202, METHOD 208
9. PULLING TEST: 2.3 KG
10. ROHS

MAXIMUM RATINGS AND ELECTRICAL CHARACTERISTICS RATINGS AT 25°C AMBIENT TEMPERATURE UNLESS OTHERWISE SPECIFIED STORAGE AND OPERATING TEMPERATURE RANGE -55°C TO + 150°C. SINGLE PHASE, HALF WAVE, 60 HZ, RESISTIVE OR INDUCTIVE LOAD. FOR CAPACITIVE LOAD, DERATE CURRENT BY 20%

RATINGS	SYMBOL	VALUE	UNITS
MAXIMUM AVERAGE FORWARD RECTIFIED CURRENT 0.375"(9.5mm) LEAD LENGTH @ TA=50°C	IO	5	A
PEAK FWD SURGE CURRENT, 8.3ms HALF SINE-WAVE SUPERIMPOSED ON RATED LOAD	IFSM	200	A
TYPICAL THERMAL RESISTANCE (NOTE 2)	Rqja	15	°C/W
MAXIMUM REVERSE CURRENT @ 25°C	IR	10	uA
MAXIMUM REVERSE CURRENT @ 100 °C	IR	100	uA

1. Cj MEASURED @ 1 MHZ AND APPLIED REVERSE VOLTAGE OF 4.0 VOLTS
2. BOTH LEADS ATTACHED TO HEAT SINK 63.5x63.5x1t(mm) COPPER PLATE @ LEAD LENGTH 5mm
3. REVERSE RECOVERY TEST CONDITIONS: IF=0.5A, IR=1.0A, IRR=0.25A
4. MAXIMUM FORWARD VOLTAGE @ Io DC

PART NUMBER	MAX RECURRENT PK REV VOLTAGE VRRM (V)	MAX RMS VOLTAGE VRMS (V)	MAX DC BLOCKING VOLTAGE VDC (V)	MAX FWD VOLTAGE VF (V)	TYPICAL JUNCTION CAP CJ (PF)	MAX REVERSE RECOVERY TIME nS
UF50-005	50	35	50	1.3	70	50
UF50-01	100	70	100	1.3	70	50
UF50-02	200	140	200	1.3	70	50
UF50-04	400	280	400	1.3	70	50
UF50-06	600	420	600	1.5	50	75
UF50-08	800	560	800	1.7	50	75
UF50-10	1000	700	1000	1.7	50	75

RATING AND CHARACTERISTIC CURVES

FIG. 1-TEST CIRCUIT DIAGRAM AND REVERSE RECOVERY TIME CHARACTERISTIC

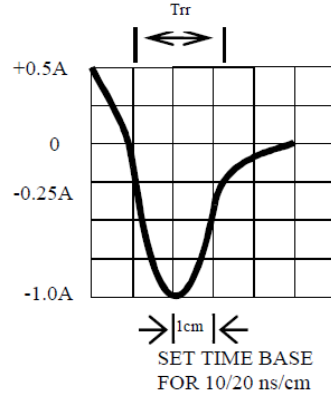
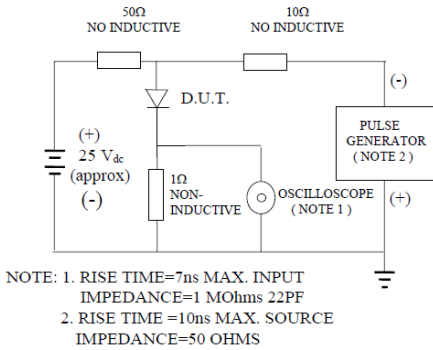

FIG. 2 -TYPICAL FORWARD CURRENT DERATING CURVE

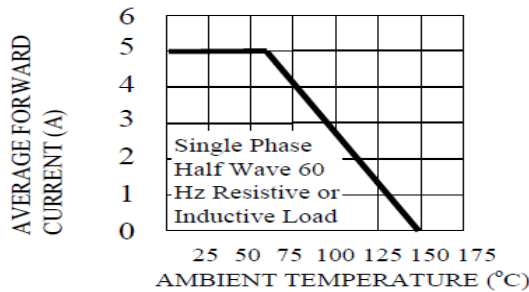

FIG. 3 -TYPICAL REVERSE CHARACTERISTICS

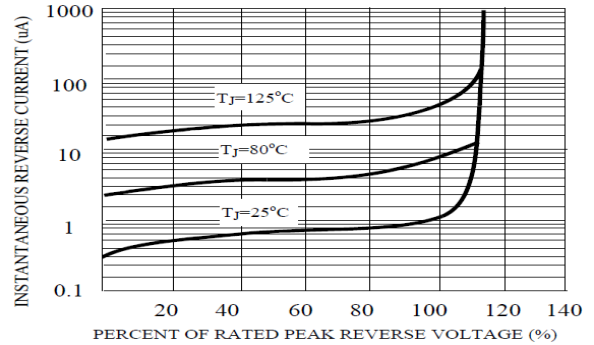

FIG. 4 -TYPICAL INSTANTANEOUS FORWARD CHARACTERISTICS

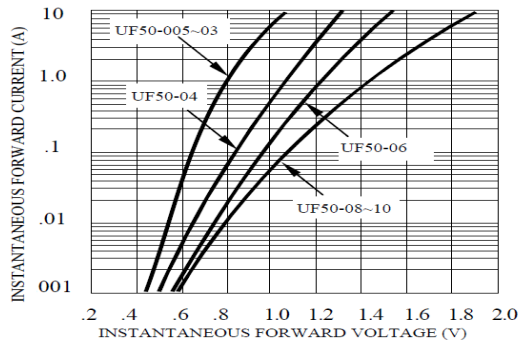
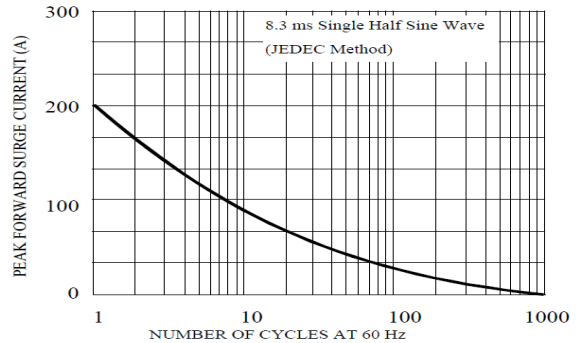

FIG. 5 -MAXIMUM NON-REPETITIVE FORWARD SURGE CURRENT





UF50-005 THRU UF50-10 SPECIFICATIONS

Rev. A

