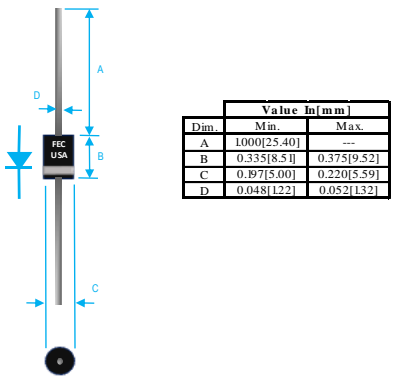

2A ULTRA FAST RECOVERY RECTIFIER

 <table border="1" style="margin-left: auto; margin-right: auto;"> <thead> <tr> <th rowspan="2">Dim.</th> <th colspan="2">Value in [mm]</th> </tr> <tr> <th>Min.</th> <th>Max.</th> </tr> </thead> <tbody> <tr> <td>A</td> <td>1.000[25.40]</td> <td>---</td> </tr> <tr> <td>B</td> <td>0.335[8.51]</td> <td>0.375[9.52]</td> </tr> <tr> <td>C</td> <td>0.297[5.00]</td> <td>0.220[5.59]</td> </tr> <tr> <td>D</td> <td>0.048[1.22]</td> <td>0.052[1.32]</td> </tr> </tbody> </table>	Dim.	Value in [mm]		Min.	Max.	A	1.000[25.40]	---	B	0.335[8.51]	0.375[9.52]	C	0.297[5.00]	0.220[5.59]	D	0.048[1.22]	0.052[1.32]	PRODUCT FEATURES <ol style="list-style-type: none"> 1. FLAMMABILITY CLASSIFICATION: 94V-0 2. LOW LEAKAGE 3. LOW FORWARD VOLTAGE DROP 4. HIGH SURGE CURRENT CAPABILITY 5. ULTRA FAST SWITCHING 6. CASE: MOLDED PLASTIC, DO15 7. POLARITY: INDICATED BY CATHODE BAND 8. WEIGHT : 0.4 GRAMS 9. TERMINALS : PER MIL-STD-202, METHOD 208 10. PULLING TEST: 2.3 KG 11. ROHS
Dim.		Value in [mm]																
	Min.	Max.																
A	1.000[25.40]	---																
B	0.335[8.51]	0.375[9.52]																
C	0.297[5.00]	0.220[5.59]																
D	0.048[1.22]	0.052[1.32]																

MAXIMUM RATINGS AND ELECTRICAL CHARACTERISTICS RATINGS AT 25°C AMBIENT TEMPERATURE UNLESS OTHERWISE SPECIFIED STORAGE AND OPERATING TEMPERATURE RANGE -55°C TO + 150°C. SINGLE PHASE, HALF WAVE, 60 HZ, RESISTIVE OR INDUCTIVE LOAD. FOR CAPACITIVE LOAD, DERATE CURRENT BY 20%

RATINGS	SYMBOL	VALUE	UNITS
MAXIMUM AVERAGE FORWARD RECTIFIED CURRENT 0.375"(9.5mm) LEAD LENGTH @ TA=55°C	IO	2	A
PEAK FWD SURGE CURRENT, 8.3ms HALF SINE-WAVE SUPERIMPOSED ON RATED LOAD	IFSM	60	A
TYPICAL THERMAL RESISTANCE (NOTE 2)	Rqja	25	°C/W
MAXIMUM REVERSE CURRENT @ 25°C	IR	5	uA
MAXIMUM REVERSE CURRENT @ 100°C	IR	100	uA

1. Cj MEASURED @ 1 MHZ AND APPLIED REVERSE VOLTAGE OF 4.0 VOLTS
2. BOTH LEADS ATTACHED TO HEAT SINK 35x35x1t(mm) COPPER PLATE @ LEAD LENGTH 5mm
3. REVERSE RECOVERY TEST CONDITIONS: IF=0.5A, IR=1.0A, IRR=0.25A
4. MAXIMUM FORWARD VOLTAGE @ Io DC

PART NUMBER	MAX RECURRENT PK REV VOLTAGE VRRM (V)	MAX RMS VOLTAGE VRMS (V)	MAX DC BLOCKING VOLTAGE VDC (V)	MAX FWD VOLTAGE VF (V)	TYPICAL JUNCTION CAP CJ (PF)	MAX REVERSE RECOVERY TIME nS
HER201G	50	35	50	1	30	50
HER202G	100	70	100	1	30	50
HER203G	200	140	200	1	30	50
HER204G	300	210	300	1.3	30	50
HER205G	400	280	400	1.3	20	50
HER206G	600	420	600	1.85	20	75
HER207G	800	560	800	1.85	20	75
HER208G	1000	700	1000	1.85	20	75

RATING AND CHARACTERISTIC CURVES

FIG. 1 -TEST CIRCUIT DIAGRAM AND REVERSE RECOVERY TIME CHARACTERISTIC

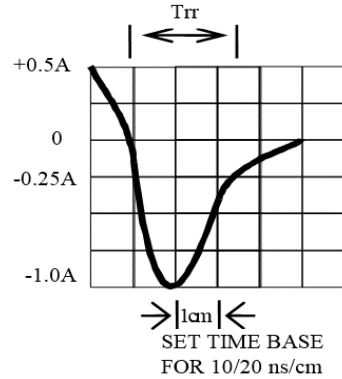
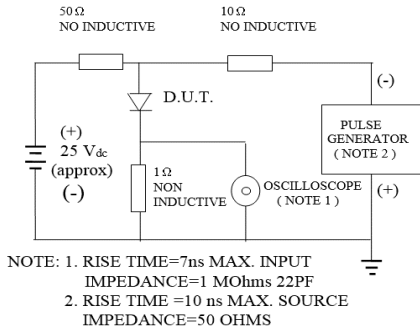

FIG. 2-TYPICAL FORWARD CURRENT DERATING CURVE

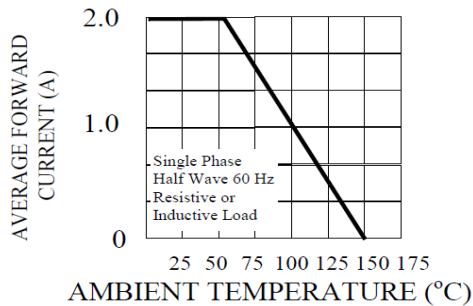

FIG. 3-TYPICAL REVERSE CHARACTERISTICS

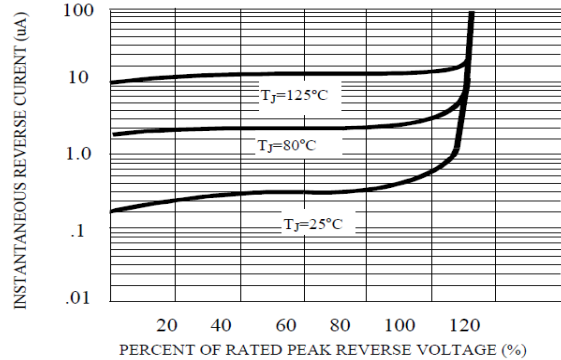

FIG. 4-TYPICAL INSTANTANEOUS FORWARD CHARACTERISTICS

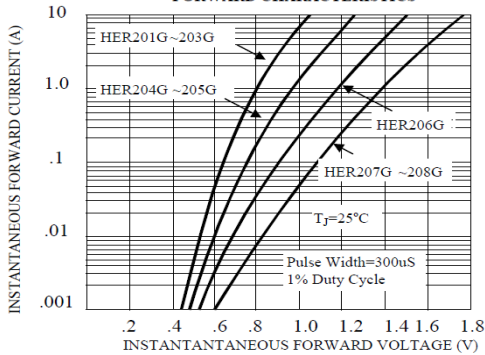
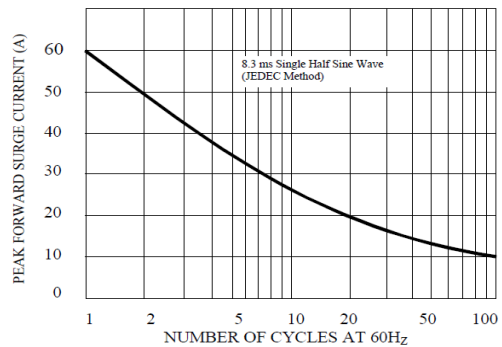

FIG. 5-MAXIMUM NON-REPETITIVE FORWARD SURGE CURRENT





HER201G THRU HER208G SPECIFICATIONS

Rev. A

