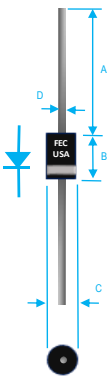

2.0A FAST RECOVERY GLASS PASSIVATED RECTIFIER

|  <table border="1" style="margin-left: auto; margin-right: auto;"> <thead> <tr> <th rowspan="2">Dim.</th> <th colspan="2">Value In (mm)</th> </tr> <tr> <th>Min.</th> <th>Max.</th> </tr> </thead> <tbody> <tr> <td>A</td> <td>1.000[25.40]</td> <td>—</td> </tr> <tr> <td>B</td> <td>0.230[5.84]</td> <td>0.300[7.62]</td> </tr> <tr> <td>C</td> <td>0.104[2.64]</td> <td>0.140[3.56]</td> </tr> <tr> <td>D</td> <td>0.028[0.71]</td> <td>0.034[0.86]</td> </tr> </tbody> </table> | Dim. | Value In (mm) | | Min. | Max. | A | 1.000[25.40] | — | B | 0.230[5.84] | 0.300[7.62] | C | 0.104[2.64] | 0.140[3.56] | D | 0.028[0.71] | 0.034[0.86] | PRODUCT FEATURES <ol style="list-style-type: none"> 1. FLAMMABILITY CLASSIFICATION: 94V-0 2. GLASS PASSIVATED CHIP JUNCTION 3. DIFFUSED JUNCTION 4. HIGH SURGE CURRENT CAPABILITY 5. CASE: MOLDED PLASTIC, DO15 6. DIMENSIONS IN INCHES AND (MILLIMETERS) 7. POLARITY: INDICATED BY CATHODE BAND 8. WEIGHT : 0.4 GRAMS 9. TERMINALS : PER MIL-STD-202, METHOD 208 10. ROHS |
|--|--------------|---------------|--|------|------|---|--------------|---|---|-------------|-------------|---|-------------|-------------|---|-------------|-------------|---|
| Dim. | | Value In (mm) | | | | | | | | | | | | | | | | |
| | Min. | Max. | | | | | | | | | | | | | | | | |
| A | 1.000[25.40] | — | | | | | | | | | | | | | | | | |
| B | 0.230[5.84] | 0.300[7.62] | | | | | | | | | | | | | | | | |
| C | 0.104[2.64] | 0.140[3.56] | | | | | | | | | | | | | | | | |
| D | 0.028[0.71] | 0.034[0.86] | | | | | | | | | | | | | | | | |

MAXIMUM RATINGS AND ELECTRICAL CHARACTERISTICS RATINGS AT 25°C AMBIENT TEMPERATURE UNLESS OTHERWISE SPECIFIED STORAGE AND OPERATING TEMPERATURE RANGE -55°C TO + 150°C. SINGLE PHASE, HALF WAVE, 60 HZ, RESISTIVE OR INDUCTIVE LOAD. FOR CAPACITIVE LOAD, DERATE CURRENT BY 20%

| RATINGS | SYMBOL | VALUE | UNITS |
|--|--------|-------|-------|
| MAXIMUM AVERAGE FORWARD RECTIFIED CURRENT 0.375"(9.5mm) LEAD LENGTH @ 55°C | IO | 2 | A |
| PEAK FWD SURGE CURRENT, 8.3ms HALF SINE-WAVE SUPERIMPOSED ON RATED LOAD | IFSM | 70 | A |
| TYPICAL JUNCTION CAPACITANCE(NOTE 1) | CJ | 40 | pF |
| TYPICAL THERMAL RESISTANCE (NOTE 2) | Rqja | 40 | °C/W |
| MAXIMUM FORWARD VOLTAGE | VF | 1.3 | V |
| MAXIMUM REVERSE CURRENT @ 25°C | IR | 5 | uA |
| MAXIMUM REVERSE CURRENT @ 100°C | IR | 50 | uA |

1. MEASURED @ 1.0 MHZ AND APPLIED REVERSE VOLTAGE OF 4.0 V
2. BOTH LEADS ATTACHED TO HEAT SINK 35x35x1t(mm) COPPER PLATE @ LEAD LENGTH 5mm
3. REVERSE RECOVERY TEST CONDITIONS: IF=0.5A, IR=1.0A, IRR=0.25A
4. MAXIMUM FORWARD VOLTAGE AT IO DC

| PART NUMBER | MAX RECURRENT PK REV VOLTAGE VRRM (V) | MAX RMS VOLTAGE VRMS (V) | MAX DC BLOCKING VOLTAGE VDC (V) | MAX REV RECOVERY TIME TRR (nS) |
|-------------|---------------------------------------|--------------------------|---------------------------------|--------------------------------|
| FR20-005G | 50 | 35 | 50 | 150 |
| FR20-01G | 100 | 70 | 100 | 150 |
| FR20-02G | 200 | 140 | 200 | 150 |
| FR20-04G | 400 | 280 | 400 | 150 |
| FR20-06G | 600 | 420 | 600 | 250 |
| FR20-08G | 800 | 560 | 800 | 500 |
| FR20-10G | 1000 | 700 | 1000 | 500 |

RATING AND CHARACTERISTIC CURVES

FIG. 1-TEST CIRCUIT DIAGRAM AND REVERSE RECOVERY TIME CHARACTERISTIC

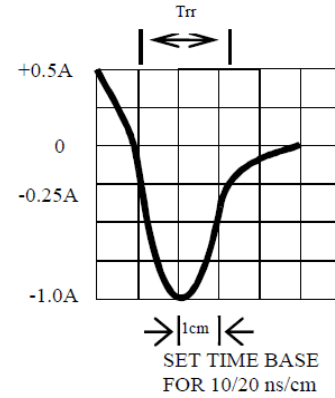
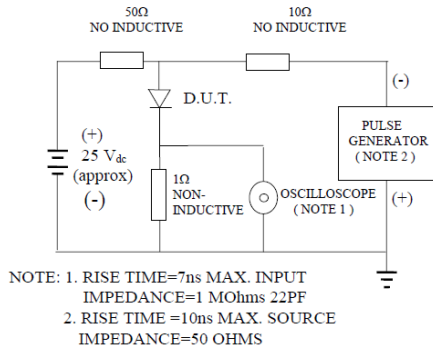

Fig. 2-MAXIMUM FORWARD CURRENT DERATING CURVE

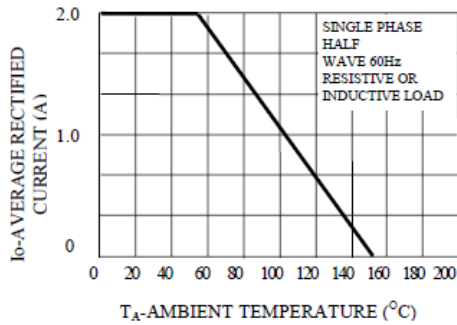

FIG. 3-TYPICAL REVERSE CHARACTERISTICS

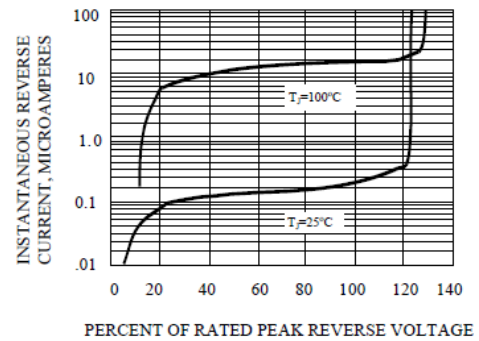

Fig. 4-MAXIMUM FORWARD SURGE CURRENT

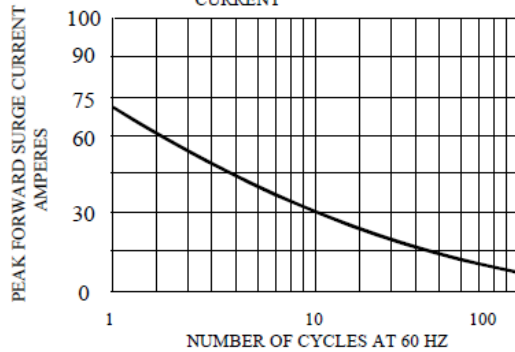
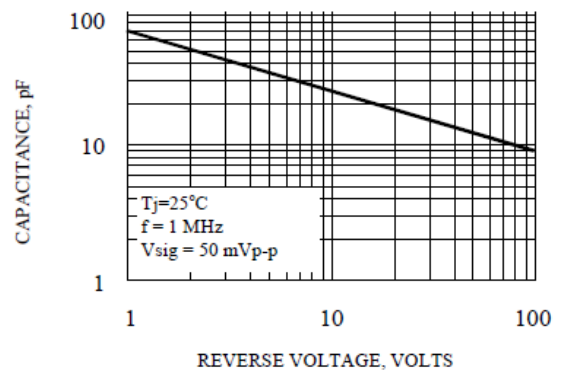

FIG. 5-TYPICAL JUNCTION CAPACITANCE





FR20-005G THRU FR20-10G SPECIFICATIONS

Rev. A

