

3A SMD SCHOTTKY BARRIER RECTIFIERS, 20V-200V

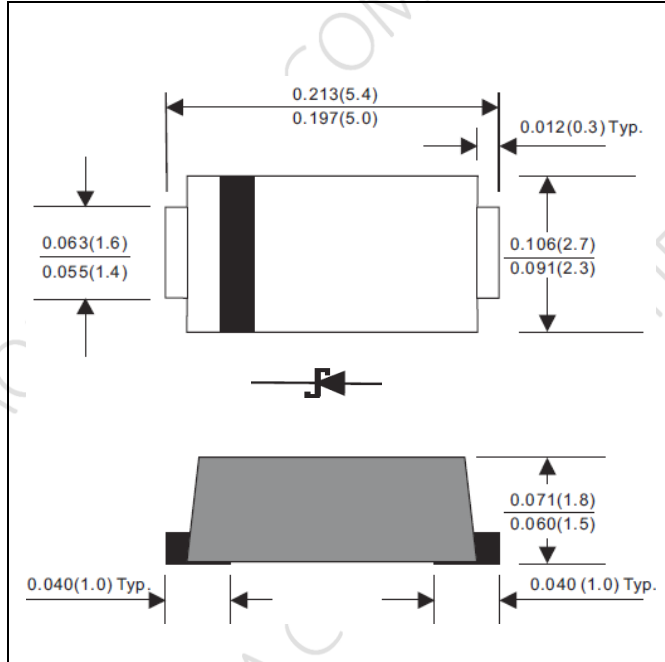

PRODUCT FEATURES

1. FLAMMABILITY CLASSIFICATION 94V-0
2. EXCELLENT REVERSE LEAKAGE CURRENT AND THERMAL RESISTANCE
3. HIGH CURRENT CAPABILITY, LOW POWER LOSS
4. SILICON EPITAXIAL PLANAR CHIP, METAL SILICON JUNCTION
5. GUARDRING FOR OVERVOLTAGE PROTECTION
6. CASE: TRANSFER MOLDED, DO-214AC (SMA-S)
7. DIMENSIONS IN INCHES AND (MILLIMETERS)
8. LEADS: SOLDERABILITY PER MIL-STD-750 METHOD 2026
9. WEIGHT: 0.05 GRAMS
10. RoHS COMPLIANT, ADD SUFFIX "H" FOR HALOGEN FREE
i.e. FM320-AS-H: RoHS COMPLIANT/HALOGEN FREE

ELECTRICAL CHARACTERISTICS

MAXIMUM RATINGS ($T_A = 25^\circ\text{C}$ UNLESS OTHERWISE NOTED) AND ELECTRICAL CHARACTERISTICS

RATING	SYMBOL		UNITS
MAXIMUM FORWARD RECTIFIED CURRENT	I_o	3	A
PEAK FORWARD SURGE CURRENT, 8.3ms SINGLE HALF SINE-WAVE SUPERIMPOSED ON RATED LOAD	I_{FSM}	80	A
TYPICAL JUNCTION CAPACITANCE BETWEEN TERMINALS (NOTE 1)	C_J	250	pF
STORAGE TEMPERATURE RANGE	T_{STG}	- 65 TO +175	$^\circ\text{C}$
OPERATING JUNCTION TEMPERATURE RANGE (NOTE 2)	T_J	- 55 TO +150	$^\circ\text{C}$
MAX. DC REVERSE CURRENT AT RATED DC BLOCKING VOLTAGE $T_J = 25^\circ\text{C}$	I_R	0.5	mA
MAX. DC REVERSE CURRENT AT RATED DC BLOCKING VOLTAGE $T_J = 100^\circ\text{C}$	I_R	20	mA
TYPICAL THERMAL RESISTANCE	$R_{\theta JA}$	60	$^\circ\text{C/W}$
	$R_{\theta JC}$	30	$^\circ\text{C/W}$

PART NUMBER	MAX RECURRENT PK REVERSE VOLTAGE/DC BLOCKING V_{RRM}/V_R (V)	MAX V_{RMS} (V)	TYPICAL FORWARD VOLTAGE AT $I_F = 3A$ V_F (V)	MARKING
FM320-AS	20	14	0.50	SK32
FM330-AS	30	21	0.50	SK33
FM340-AS	40	28	0.50	SK34
FM345-AS	45	31.5	0.50	SK34
FM350-AS	50	35	0.70	SK35
FM360-AS	60	42	0.70	SK36
FM380-AS	80	56	0.85	SK38
FM3100-AS	100	70	0.85	S310
FM3150-AS	150	105	0.90	S315
FM3200-AS	200	140	0.92	S320



- NOTE : 1. MEASURE AT 1MHz WITH 4VDC REVERSE VOLTAGE APPLIED .
 2. FOR THE FM320-AS THRU FM345-AS, THE OPERATING JUNCTION TEMPERATURE RANGE IS FROM -55 TO +125°C
 3. CURRENT RATING IS BASED ON SINGLE PHASE, 1/2 WAVE, 60HZ, RESISTIVE, OR INDUCTIVE LOAD. FOR CAPACITIVE LOAD, DERATE CURRENT BY 20%.

RATINGS AND CHARACTERISTIC CURVES

FIG.1-TYPICAL FORWARD CURRENT DERATING CURVE

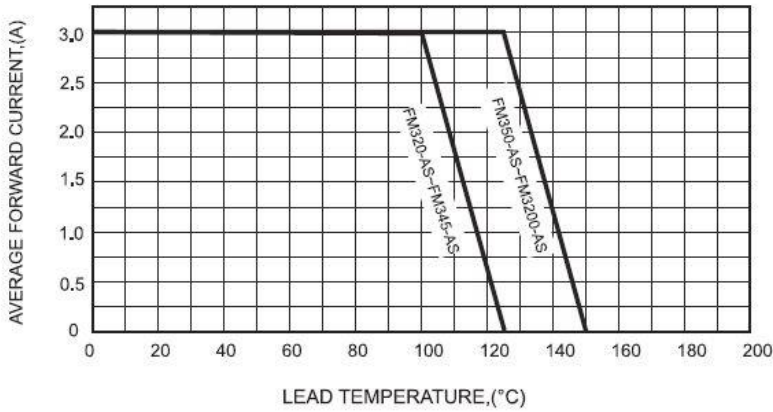

FIG.2-TYPICAL FORWARD CHARACTERISTICS

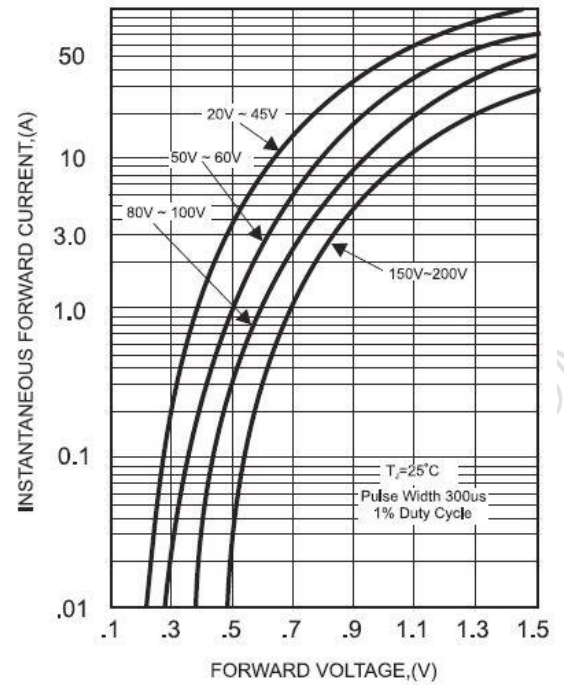

FIG.3-MAXIMUM NON-REPETITIVE FORWARD SURGE CURRENT

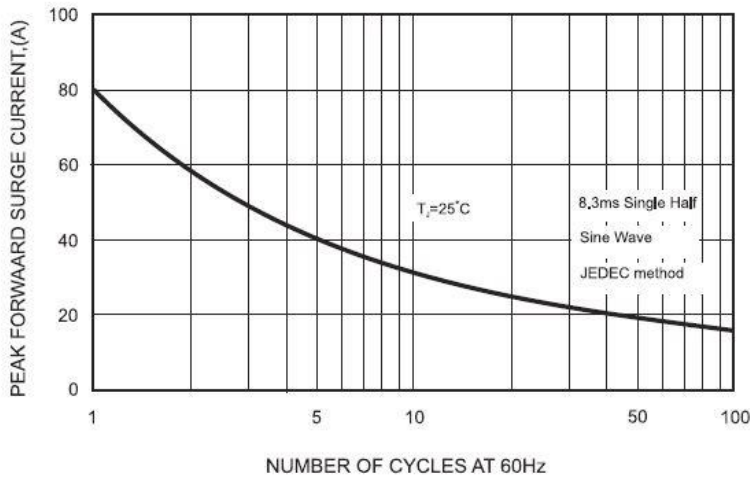

FIG.4-TYPICAL JUNCTION CAPACITANCE

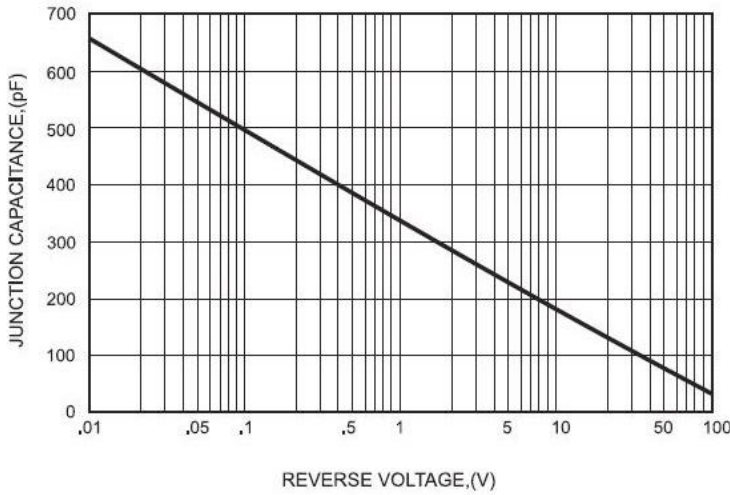
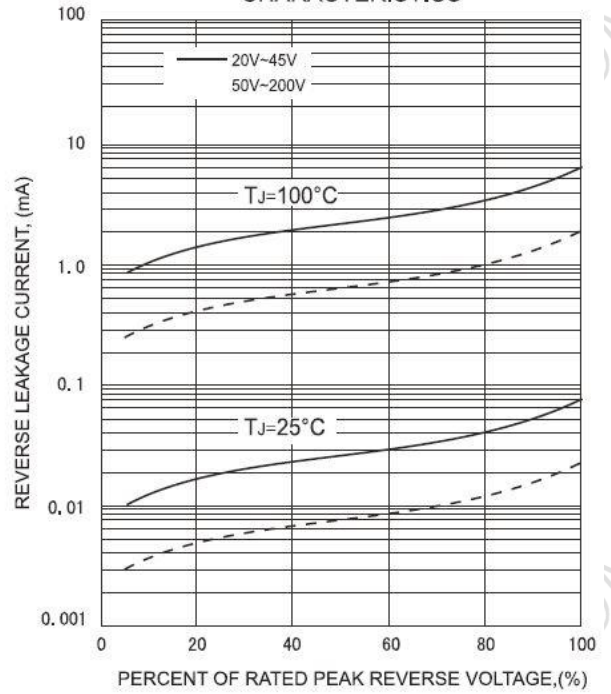
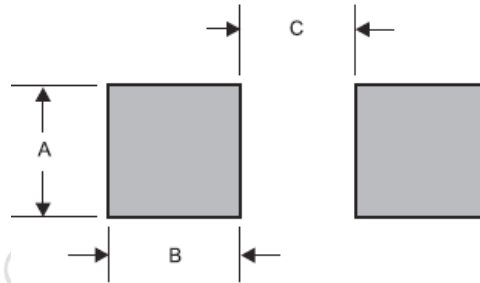

FIG.5 - TYPICAL REVERSE CHARACTERISTICS



LAYOUT RECOMMENDATION



PACKAGE	A	B	C
SMA-S	0.063 (1.60)	0.059 (1.50)	0.110 (2.80)