

## 1A SMD SCHOTTKY BARRIER RECTIFIERS, 20V-200V

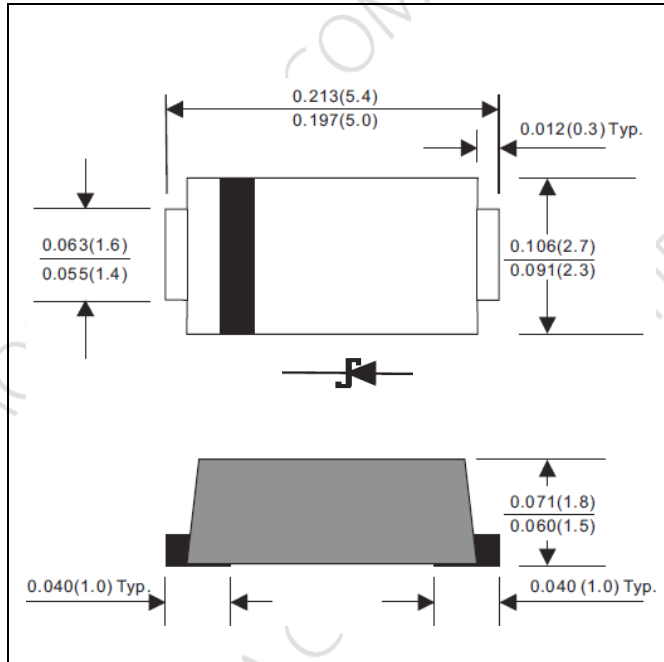

### PRODUCT FEATURES

1. FLAMMABILITY CLASSIFICATION 94V-0
2. EXCELLENT REVERSE LEAKAGE CURRENT AND THERMAL RESISTANCE
3. HIGH CURRENT CAPABILITY, LOW POWER LOSS
4. SILICON EPITAXIAL PLANAR CHIP, METAL SILICON JUNCTION
5. GUARDRING FOR OVERVOLTAGE PROTECTION
6. CASE: TRANSFER MOLDED, DO-214AC (SMA-S)
7. DIMENSIONS IN INCHES AND (MILLIMETERS)
8. LEADS: SOLDERABILITY PER MIL-STD-750 METHOD 2026
9. WEIGHT: 0.05 GRAMS
10. RoHS COMPLIANT, ADD SUFFIX "H" FOR HALOGEN FREE  
i.e. FM120-S-H: RoHS COMPLIANT/HALOGEN FREE

## ELECTRICAL CHARACTERISTICS

### MAXIMUM RATINGS ( $T_A = 25^\circ\text{C}$ UNLESS OTHERWISE NOTED ) AND ELECTRICAL CHARACTERISTICS

RATING	SYMBOL		UNITS
MAXIMUM FORWARD RECTIFIED CURRENT	$I_o$	1	A
PEAK FORWARD SURGE CURRENT, 8.3ms SINGLE HALF SINE-WAVE SUPERIMPOSED ON RATED LOAD	$I_{FSM}$	30	A
TYPICAL JUNCTION CAPACITANCE BETWEEN TERMINALS (NOTE 1)	$C_J$	120	pF
STORAGE TEMPERATURE RANGE	$T_{STG}$	- 65 TO +175	$^\circ\text{C}$
OPERATING JUNCTION TEMPERATURE RANGE (NOTE 2)	$T_J$	- 55 TO +150	$^\circ\text{C}$
MAX. DC REVERSE CURRENT AT RATED DC BLOCKING VOLTAGE $T_J = 25^\circ\text{C}$	$I_R$	0.5	mA
MAX. DC REVERSE CURRENT AT RATED DC BLOCKING VOLTAGE $T_J = 100^\circ\text{C}$	$I_R$	10	mA
TYPICAL THERMAL RESISTANCE	$R_{\theta JA}$	72	$^\circ\text{C}/\text{W}$
	$R_{\theta JC}$	36	$^\circ\text{C}/\text{W}$

PART NUMBER	MAX RECURRENT PK REVERSE VOLTAGE/DC BLOCKING $V_{RRM}/V_R$ (V)	MAX $V_{RMS}$ (V)	TYPICAL FORWARD VOLTAGE AT $I_F = 1\text{A}$ $V_F$ (V)	MARKING
FM120-S	20	14	0.50	SK12
FM130-S	30	21	0.50	SK13
FM140-S	40	28	0.50	SK14
FM150-S	50	35	0.70	SK15
FM160-S	60	42	0.70	SK16
FM180-S	80	56	0.85	SK18
FM1100-S	100	70	0.85	S110
FM1150-S	150	105	0.90	S115
FM1200-S	200	140	0.92	S120

NOTE : 1. MEASURE AT 1MHz WITH 4VDC REVERSE VOLTAGE APPLIED .

2. FOR THE FM120-S, FM130-S, AND FM140-S, THE OPERATING JUNCTION TEMPERATURE RANGE IS FROM -55 TO +125 $^\circ\text{C}$



3. CURRENT RATING IS BASED ON SINGLE PHASE, 1/2 WAVE, 60HZ, RESISTIVE, OR INDUCTIVE LOAD. FOR CAPACITIVE LOAD, DERATE CURRENT BY 20%.

## RATINGS AND CHARACTERISTIC CURVES

FIG.1-TYPICAL FORWARD CURRENT DERATING CURVE

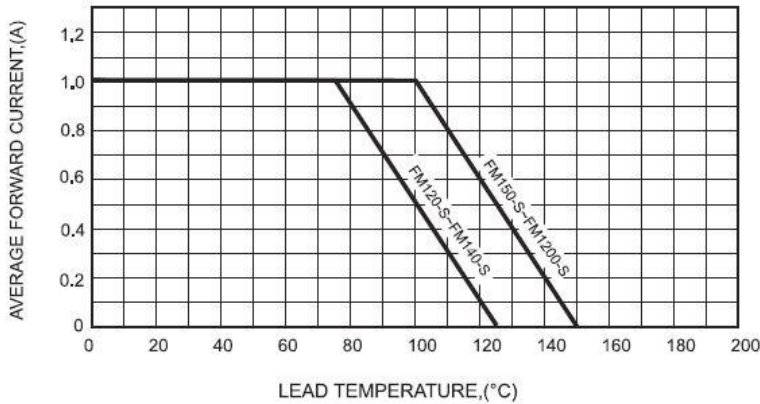

FIG.2-TYPICAL FORWARD CHARACTERISTICS

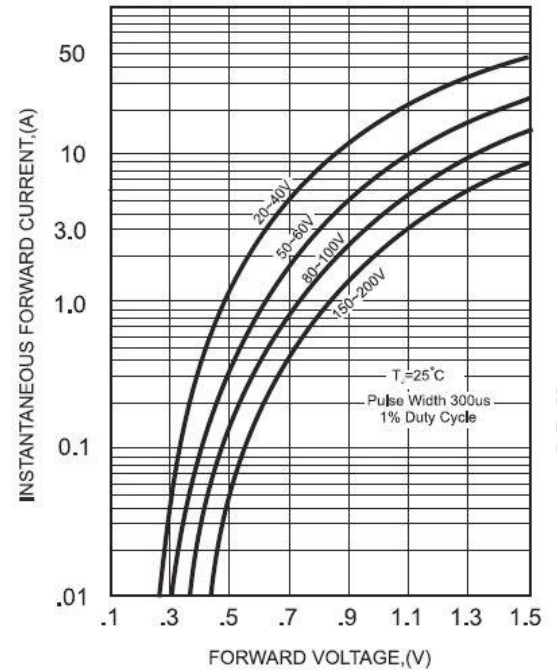

FIG.3-MAXIMUM NON-REPETITIVE FORWARD SURGE CURRENT

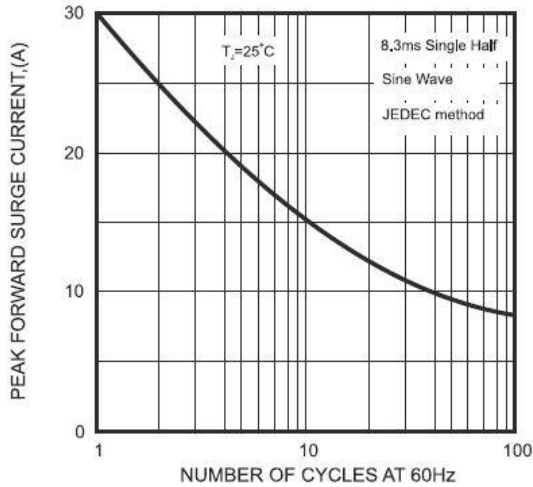

FIG.4-TYPICAL JUNCTION CAPACITANCE

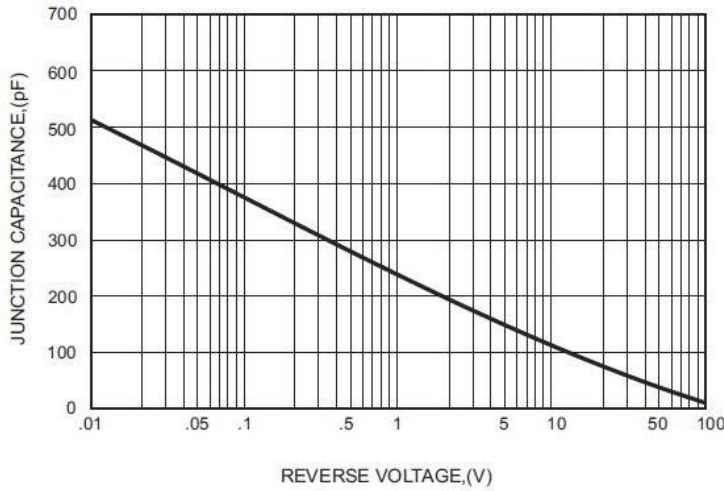
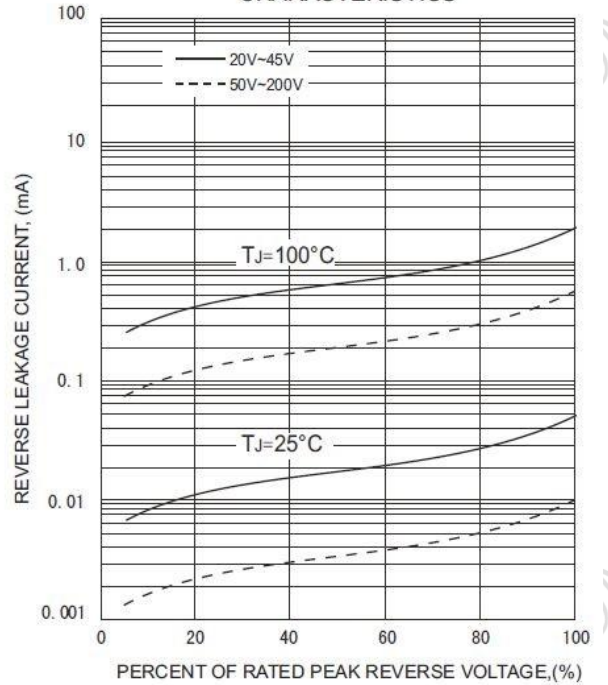
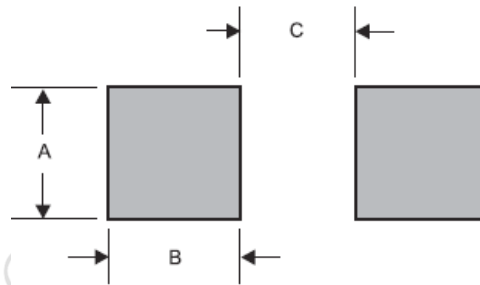

FIG.5 - TYPICAL REVERSE CHARACTERISTICS



## LAYOUT RECOMMENDATION



PACKAGE	A	B	C
SMA-S	0.063 (1.60)	0.059 (1.50)	0.110 (2.80)